

Airwheel Z3

OPERATING GUIDE

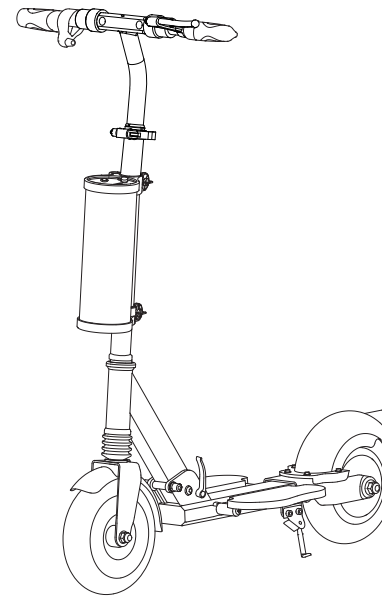

Check Packing Contents

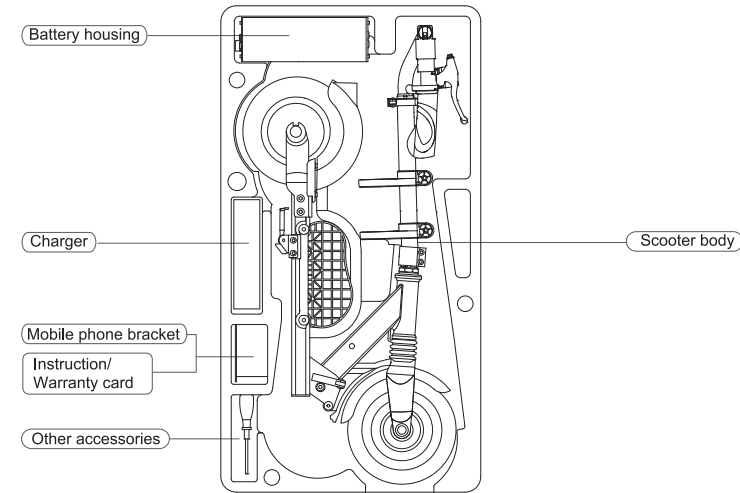

Packing Details

Scooter body	1 piece	Charger	1 piece
Battery housing	1 piece	Other accessories	1 unit
Mobile phone bracket	1 piece	Instruction book / Warranty card	1 unit

Diagram

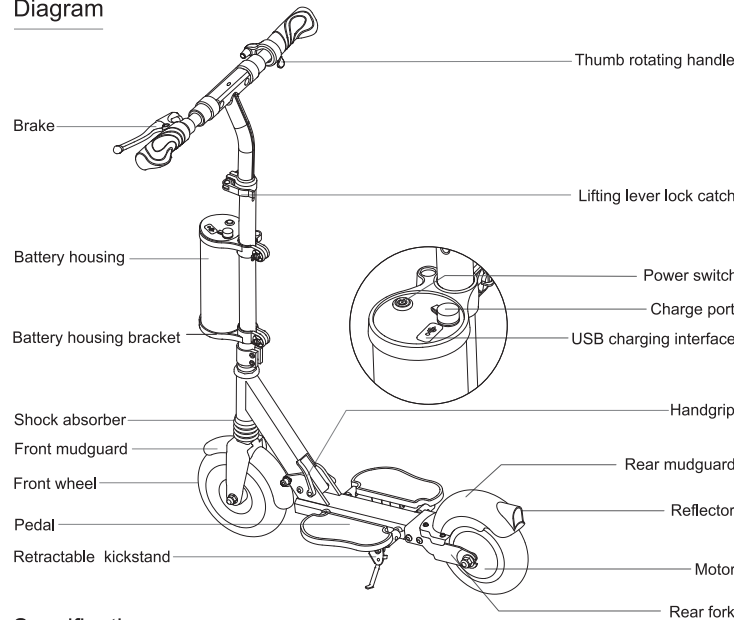

Specifications

Size	1003mm × 830mm × 585mm	Max Load	100kg
Weight	12kg	Max Speed	~20km/h
Tire Size	8inch	Max. Climbing Angle	~15°
Charge Voltage	AC220V 50-60Hz	Pedal Height	140mm
Charge Time	162.8Wh: 120min	Working Temperature	-10°C~40°C
USB Output Voltage	5V	USB Maximum Current Output	1.5A

Put Together the Scooter

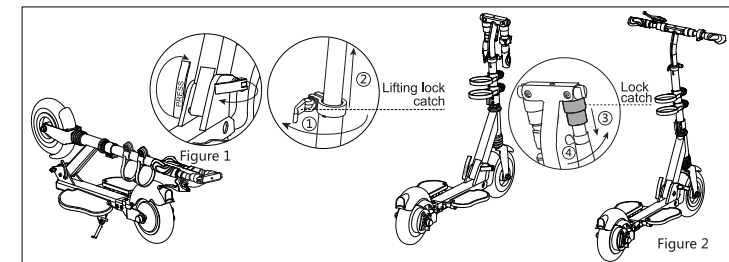

1. Unfold the pedals and hold the scooter head with hands, push the handle with the "PRESS" word (see the left arrow in Figure 1). Push forward the scooter frame until hear a "click" sound, set up the scooter head and close lock catch (see the right arrow in Figure 1). Open the lifting lock catch (see ① arrow). Lift the scooter head (see ② arrow) and close lock catch.
2. Pull down the lock catch on the handle gently (see ③ arrow) and rotate upward (see ④ arrow) until reach horizontal position. The lock catch will rebound and close automatically and the same to the other handle. Now, the Airwheel Z3 is as Figure 2.

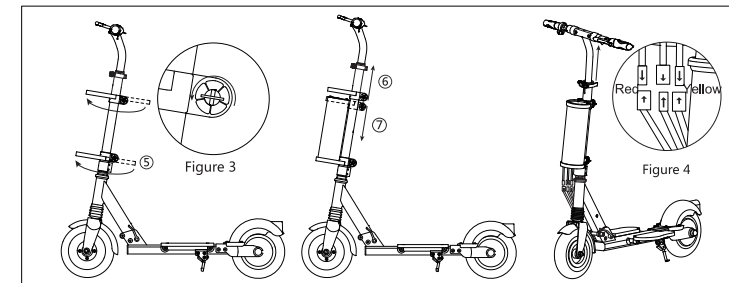

3. Rotate the two screws counterclockwise (see Figure 3), and rotate battery housing brackets 180 degrees after they unscrew (see ⑤ arrow).
4. Move up battery housing upper bracket (see ⑥ arrow), put the battery housing into lower bracket, then move down the battery housing upper bracket (see ⑦ arrow), and tighten the screws to hold the battery housing.
5. Connect the male plug with female plug with in same color aligning with arrows (see figure 4), press on the locking button with the thumb, and adjust the head height, close lifting lock catch.

Foldable

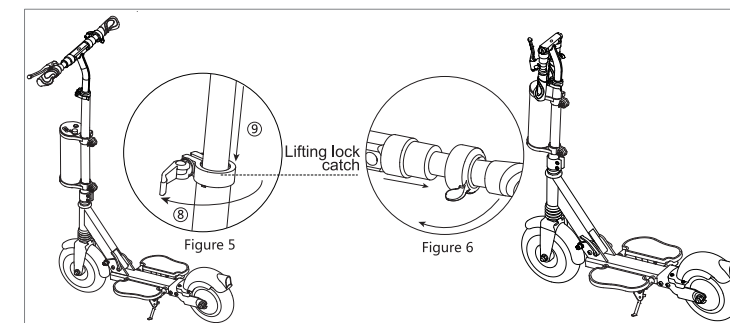

1. Open lifting lock catch (see Figure 5-⑧ arrow), bring down the scooter head (see Figure 5-⑨ arrow), and close lifting lock catch. Pull outward the lock catches on the handles and rotate downward to horizontal position (see Figure 6).

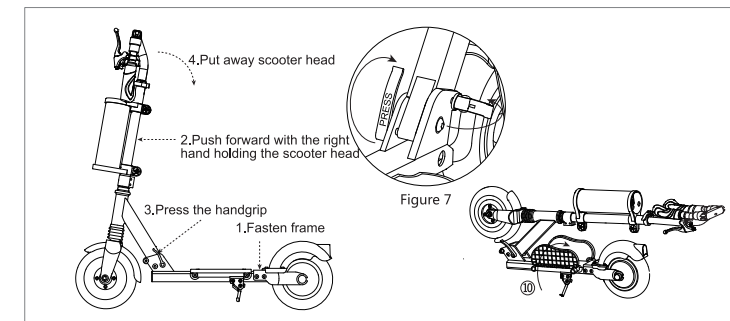

2. Open the lock button (see the right arrow in Figure 7), fasten the frame, push forward with the right hand holding the head, and press the handgrip with the word "PRESS" (see the left arrow in Figure 7), put away scooter head, fold pedals (see ⑩ arrow), and folding is completed.

Get Started

Set right the head of Z3, and adjust the handle and vehicle body to ensure riding comfort. In the battery housing to find the power, turn on the power switch, to grasp the handle, and feet set on the pedal one by one. The right hand toggle accelerator to speed up, and then the rider can get on to ride.

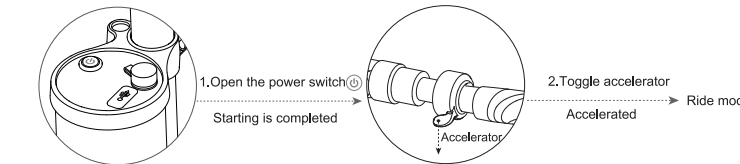

Other Functional Instructions

- USB charging interface Chargeable (compatible with mobile phones and digital equipment)

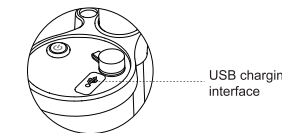

Safety

Please read notices carefully and follow riding requirements during the Z3 ride.

Important Note:

No urgent acceleration, rapid deceleration and sharp turns. Do not excessively lean forward and backward. Do not over speed. When the electric quantity displays less power or power switch lights flash, it is recommended that the rider stop riding. If riding, please keep a low constant speed. If there is a risk of falling, please protect personal safety first, do not consider Z3. Z3 scooter may produce wear and tear which have influence on the performance in the process of riding and parking. So before rider rides the Z3 scooter, it is necessary to do the following inspections:

1. Rider needs to check whether the Z3 scooter is installed firmly, and is damaged or not.
2. Rider needs to check the brake function and tyres, and to check whether the handle is fastened. If not, please tighten the screws.
3. Rider needs to check whether folding mechanism has been locked.
4. Rider needs to find an open space to practice, at least 4m*20m area, indoor and outdoor.
5. Rider needs to have a full understanding of the surrounding environment to avoid the interference from the vehicle, pedestrians, pets, bicycles and other obstacles.
6. Rider needs a skilled assistant in the side. The assistant is proficient in riding Z3 and familiar with the guidelines for the use of scooters in all matters needing attention and riding method.

Attention:

1. Do wear helmet, gloves, elbow/knee pads or other necessary protection gears.
2. Do not ride on the bumpy and wet roads, such as earth road, cobbled road or snowing and watery roads.
3. Do not ride Airwheel on slopes of over 15° gradient.
4. Do not allow children under 15 or the aged above 60 to ride Airwheel.
5. Drunk or drug riding Airwheel is prohibited.
6. Do not ride Airwheel in extremely cold winter.
7. Do not ride Airwheel in the rain.
8. Please slow down on the upper and lower slopes.
9. Do not ride Airwheel in other unadvised situations causing by either personal or objective reasons.
10. This product might be limited to use on private road (check the regulations in force in the territory of use). We recommend using suitable protective equipment.

You need lots of practice to grasp the skill before you ride the scooter safely. If you are not skilled, or fail to follow the user guide of this product, it may cause rider or others injury or property loss. Our company only takes the responsibility for product defects or damage, and we are NOT responsible for physical injury or property loss related with using products.

Download APP



Scan QR code to download

*Support Android 4.3 or higher, iOS 7.0 or higher.

APP Instructions

1. Turn on Z3 power button, and start App as well as Bluetooth.
2. Do as the follows to connect (verify password is 11111111).
3. Refer to official website or give calls for details.

Version 1



Click App's wireless connection icon.

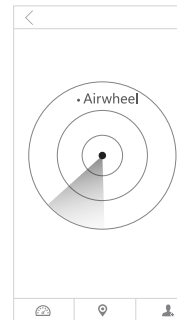

Search Airwheel nearby, click the searched Airwheel model to connect.

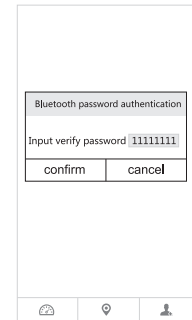

Input the verify password: 11111111 to connect.

Version 2



Click the search button.



Search Airwheel nearby, click the searched Airwheel model to connect.

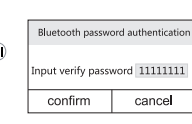

Input the verify password: 11111111 to connect.

Don'ts

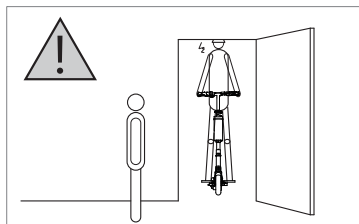

Entrance Height

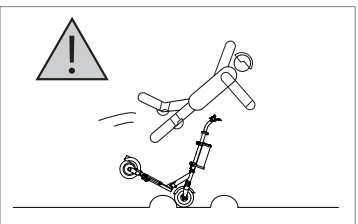

Bumpy Terrains

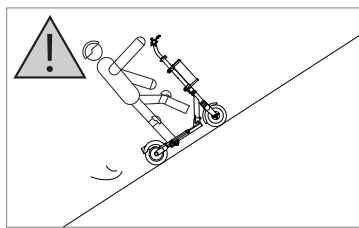

Slope Angle > 15°

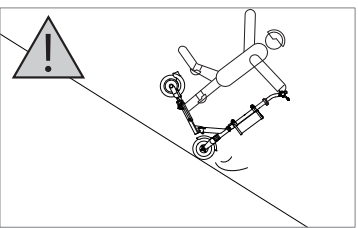

Slope Angle > 15°

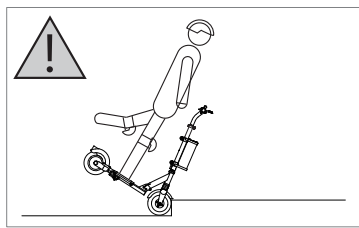

Staircases

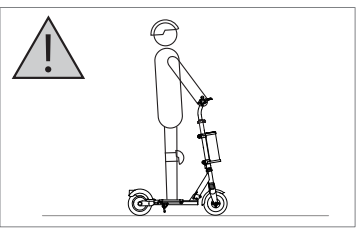

Do not remain on the standing board after shutdown.

Learn To Steer

OPERATING STEPS FOR BEGINNERS

1. Hold the handle and push the power button to start Z3 scooter.
2. One foot steps on the pedal and look straight ahead. The other foot pushes forward to give an initial velocity, toggle accelerator to speed up.
3. When riders need to slow down or stop Z3, riders put their fingers on the brake handle, and press the brake handle hard until the scooter slows down or stops.
4. When the brake is started, the accelerator is automatically cut off power.

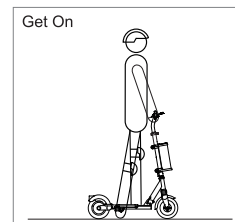
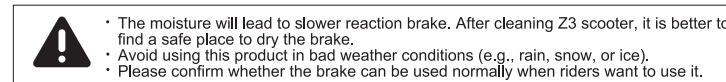

Get On
Turn the power on and step on the pedal one foot by one foot.

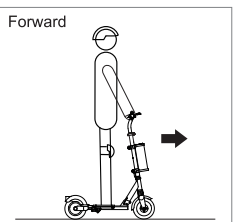

Forward
Toggle accelerator.

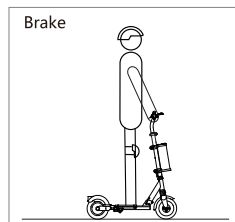

Brake
Hold the hand brake to brake.

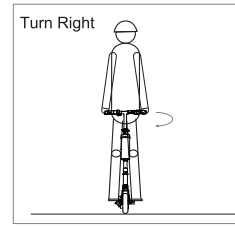

Turn Right
Turn the head to the right.

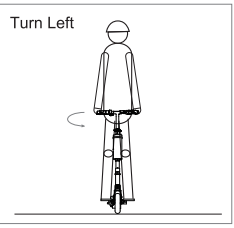

Turn Left
Turn the head to the left.

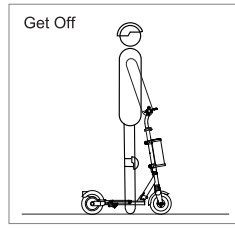

Get Off
Get off from the pedal one foot by one foot.

Warranty

Please properly keep the warranty card and purchase invoices as after-sales credential. Z3 will provide the following after-sales services providing not damaged by the user.

After-sales Service

1. The electric scooter will be guaranteed for one year, except the batteries and consumable items.
2. We can maintain the battery and charger for half year; since tires belong to consumable material one month is provided for maintenance.

Following circumstances are not included in the free repairing scope.

1. Malfunction is caused by users who are not in accordance with the provisions of the operation instruction handbook to use, maintain and adjust.
2. Damage and failure is caused by users' self-refit, self-repair and without compliance with application regulations.
3. Failure is caused by user improper safekeeping or accidents.
4. There is no warranty card and invoice or discrepancy between the vehicle and the card.
5. The appearance damage after using does not belong to the warranty scope.
6. Self-demolition piece used is excluded from Operation Manual.
7. Damage is caused riding in the rain and soaking in water.

QUALIFICATION CERTIFICATE

Doc. No. : V2.4

Record of extended warranty

Part Name	Start Date of Extended Warranty	Extended Period
Part Name	Start Date of Extended Warranty	Extended Period
Part Name	Start Date of Extended Warranty	Extended Period

Please refer to the mars rover official website for latest info update.

User Info

Name: _____ Tel: _____ Email: _____

Address: _____

Product Info

Model: _____ Service Center: _____

Repair Date: _____

Repair Details: _____

Cause of Malfunction: _____

SN: _____

Signature of the Repairman: _____

Seal of the Service Center

Aftersales info

Please visit our official website for the address of the service center and other related info.

Authorized by: Airwheel Holding Limited
Manufactured/Dealed by: Changzhou Airwheel Technology Co., Ltd.
Address: 5th Floor, East Wing, Building No.10, High - Tech Park, Kewu Road, Xinbei District, Changzhou, Jiangsu, China

Website: www.airwheel.net

E-mail: after-sale@airwheel.net



www.airwheel.net

Data is only for reference. Be subject to the real object.